



PATROL



THE LIVING LEGACY. GO ANYWHERE, ANYTIME.

Building on the impressive achievements of the first generation was the soft-top Nissan PATROL 60 series or G60. This three-door, four-seat model was first sold in Australia in 1960 and was with short-, medium- and long- wheelbase chassis. It has a 3956cc petrol engine, four-speed manual gearbox and leaf-springs all-around.

The second generation Nissan PATROL captured the imagination of the Australian market when it became the first vehicle to cross the treacherous Simpson Desert. This daunting desert covers an area of 176 500sq km and contains the longest parallel sand dunes in the world, some of which are over 40m high.



1960-1980

SECOND GENERATION G60

The Y60 Nissan PATROL, was introduced to the world in 1987, and was radically different from its predecessors. It had coil-spring suspension and the rear axle was on a 5 link setup which considerably improved the Nissan PATROL'S on-road handling, whilst still retaining its unmatched and legendary off-road performance. This model also had a five-speed transmission and all-round disc brakes. Some Y60s even featured a PTO-driven front mounted winch.

As a result of its superb wheel articulation (making it the perfect vehicle for rock-crawling) combined with the ease with which parts can be replaced out in the field, it is still being manufactured for military purposes in Asia and the Middle East.



1987-1997

FOURTH GENERATION Y60

In 2004 the significantly face-lifted Nissan PATROL Y61 was released. It boasted new headlights, box flares on each guard, larger tail lights and an extra 40l fuel tank and could seat up to ten people. Nissan also made a two-door pickup version of the Y61 series available as a bare chassis and cab. The Y61 series is still a favourite amongst off-road enthusiasts.

Thanks to the Nissan PATROL Y61's dependability and superior 4X4 capabilities, it was selected for the Miles Ahead Expedition into Africa undertaken by Barclays Bank in 2005. This voyage saw the Nissan PATROL team covering 17 countries in total, and some of the world's most inhospitable terrain in only 157 days.



2004 - 2010

SIXTH GENERATION Y61 FACELIFT

FIRST GENERATION 4W60

1951-1960



The Nissan PATROL legacy began in 1951 with the 4W60. It had an authentic 4X4 chassis, selectable 4WD and a powerful 6-cylinder engine. The 4W60 quickly proved to be the most reliable, rugged and downright versatile 4X4 available, and it was not long before it became the preferred mode of off-road transportation in many parts of Asia.

The first generation Nissan PATROL went through many changes as Nissan made constant improvements to the engine and look of the vehicle. The 4W65, which was introduced in October 1958, was the first to boast a Nissan badge on the grille and PATROL badge. The 4W73, which was launched in 1959, marked the end of the impressive first generation.

THIRD GENERATION 160 SERIES

1980-1987



Next in line was the Nissan PATROL 160 series, which was launched in 1980. With a five-door layout and seating for seven people, the 160 was the ultimate family adventure vehicle of the 80's. Air conditioning and power steering were big and welcomed improvements and some versions also featured Limited Slip Differentials (LSD), which further improved off-road handling.

The 160 series quickly came to be loved and respected for its uncompromising quality and strength, and these are still a common sight in challenging terrains everywhere. The third generation Nissan PATROL'S reputation was further strengthened by winning first place in the Paris-Dakar Rally in 1984 and second place in 1985 in the Production Diesel class.

FIFTH GENERATION Y61

1997-2004



When the Y61 hit the market in 1997 it was clear that Nissan not only stayed true to the traditions of the original Nissan PATROL but surpassed it. Its underbody hardware was so significantly strengthened that it is still considered to be the strongest components fitted to any production 4WD.

Technological developments included an automatic gearbox, electric windows and mirrors plus the fitment of a chilled cooler box between the front seats. Nissan also added a host of safety features including all-round ABS for the fully ventilated disc brakes, powerful Halogen headlamps and a reinforced cabin structure with side impact beams. This remarkable 4x4 came third in the 2003 FIA cross-country Rally World cup in the T1 class and won the 2004 Dakar Rally in the T1 class.

SEVENTH GENERATION Y62

2010-2017



The 7th generation Patrol, the Y62, was launched in 2010 globally. New from the ground up, and mechanically superior from previous Patrols, it introduced Nissan's state-of-the-art Hydraulic Body Motion Control (HBMC) suspension system. Along with a VK56VD 5.6 litre V8 engine, intuitive technology, an imposing new front design and interior refinement, the New Nissan Patrol took sophistication and capability to a whole new level.

In 2013 a World Guinness record was achieved by a Nissan Patrol pulling a 170 ton cargo plane. In 2014 a significant facelift was followed in 2015 with a record for fastest ascension of a 100m sand dune. The daunting 49 degrees slope was conquered in a time of 4.9 seconds, with the help of Intelligent Hill Start Assist (HAS) and Hydraulic Body Motion Control (HBMC) System.



THE NEW NISSAN PATROL. OVERTHROW ORDINARY.

The new Nissan PATROL brings a suite of technological features under Nissan's Intelligent Mobility technologies, and firmly retains the PATROL'S reputation as the most technologically advanced SUV in its class.

The Nissan PATROL takes proven performance, versatility and reliability and ups the ante with superbly sophisticated styling and superior comfort and a host of advanced technologies and safety features.

Over more than six decades, the Nissan PATROL has built and consolidated its reputation for being "King of the Off-Road" throughout Africa's unforgiving landscape. Pair this with superior handling on-road, now the Nissan PATROL elevates that coveted reputation even further.



REDEFINE THE STANDARD OF LUXURY AND SOPHISTICATED TECHNOLOGY.

By combining functionality, versatility and powerful performance with an attractive design, superior styling and refinement, the Nissan PATROL takes sophistication and capability to a whole new level. Nissan PATROL offers the discerning motorist modern bold styling, innovative safety features, highly advanced intelligent technologies, supreme comfort and more.

The impressive exterior of the Nissan PATROL shields an interior that offers nothing short of first class comfort and style. The designers of the Nissan PATROL have paid significant attention to every detail, large panelled wooden areas, chrome finishes and soft touch leather gives this vehicle a status of sophistication.

THE VEHICLE THAT KNOWS NO BOUNDARIES.

WHATEVER TERRAIN NATURE THROWS AT YOU, NISSAN PATROL'S ADVANCED INTELLIGENT TECHNOLOGY ENSURES A FIRM GRIP AT ALL TIMES.

INTELLIGENT 4X4

Utilising advanced electronics to ensure that no matter how severe the driving conditions, the Nissan PATROL will grip the road at all times, transferring drive between wheels and axles. Effortlessly switch between four drive modes; sand, on-road, snow and rock with just a flick of a switch.

HILL START ASSIST

Break pressure is applied 2 seconds after releasing the pedal to avoid any roll back before moving forward. Feel secure on a slope particularly in sandy or gravel conditions.

HILL DESCENT CONTROL

The Nissan PATROL assists the driver down a steep or slippery slope at a constant slow speed without the need for braking, enabling the driver to concentrate on handling the vehicle.

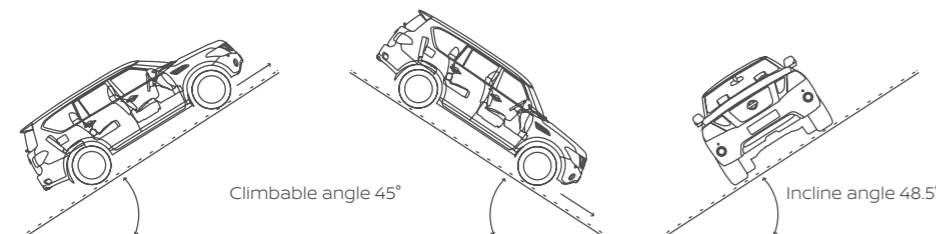



RAW POWER THAT PUTS YOU AHEAD OF THE PACK.

From the very beginning, the Nissan PATROL has been synonymous with power. Each new model has employed advanced technologies that enhance both on and off-road performance to unsurpassable levels. The latest generation Nissan PATROL is no exception.

5.6l V8 engine offers the ultimate power trip. Variable Valve Event and Lift (VVEL) and Direct Injection Gasoline (DIG) technologies improve efficiency, power and torque with lower emissions. The **7-speed** VVEL automatic transmission with manual mode, delivers seamless acceleration with **298kW** of power and **569Nm** of torque.

298 KW
Power

560 NM
Torque

7-SPEED
Auto transmission



FIRST-CLASS LEVELS OF COMFORT.

EVERY JOURNEY IN THE NISSAN PATROL IS MORE ENJOYABLE THAN THE PREVIOUS ONE.

In keeping with the Nissan PATROL's mission to deliver more comfort and more room, the Nissan PATROL offers versatile luxury leather seat dimensions that outclass the competition. Voluminous cushions for enhanced comfort on 3 rows of more-luxurious-than-ever seating, while the lavish space around the 2nd row seats is reminiscent of a private jet, the 3rd row seats offer unprecedented comfort thanks to the new reclining and sliding mechanism.

The possible 8 different seating/cargo configurations in the 1st, 2nd and 3rd row create the biggest rear luggage space in its class with the ultimate comfort.

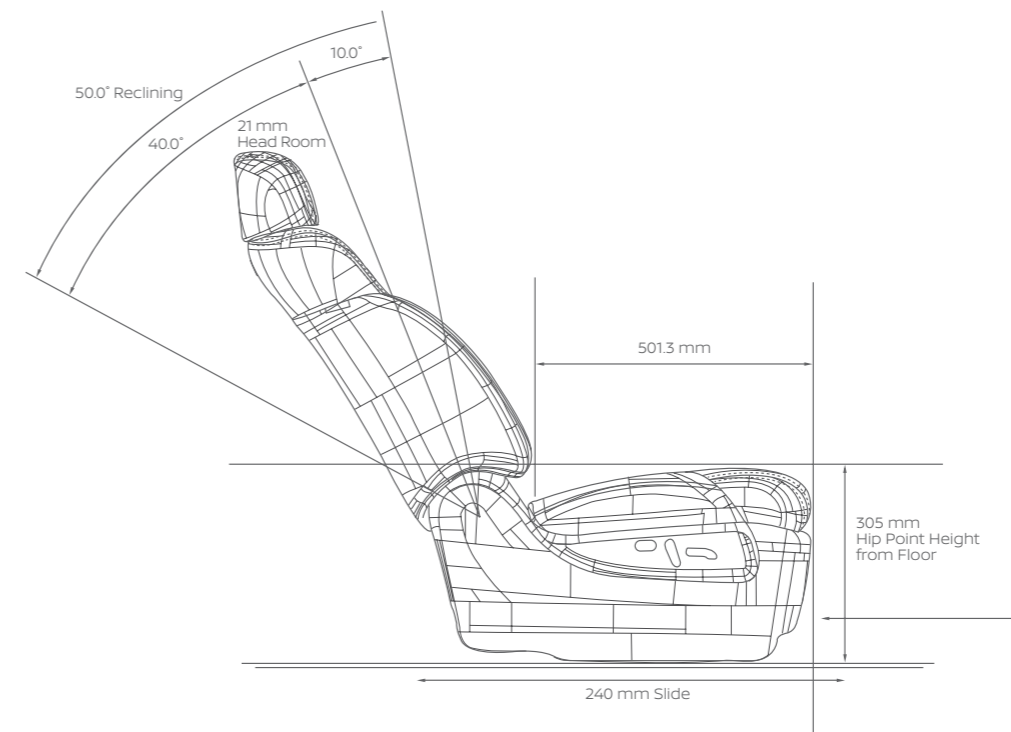



ENHANCED INTERIOR COMFORT
AND LUXURY FOR THE WHOLE FAMILY.

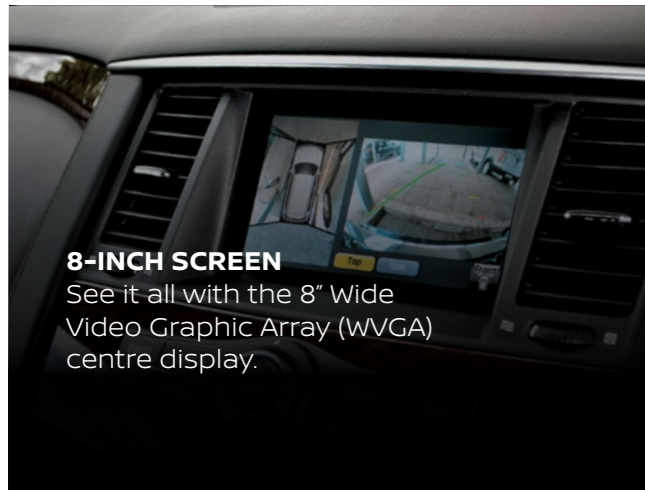

8-INCH SCREEN

See it all with the 8" Wide Video Graphic Array (WVGA) centre display.



INSTRUMENT PANEL

The fine vision instrument display provides all of the driver's information needs.



BLUETOOTH®

Stay connected with Bluetooth® capabilities in the Nissan PATROL. Radio AM/FM, CD/MP3 player with 2GB HDD music box, Bluetooth, USB and iPod connectivity.



MONITOR DISPLAY

The three monitors display three different screens, connecting to the various sources of music, video and entertainment, such as the DVD, iPod and game player.

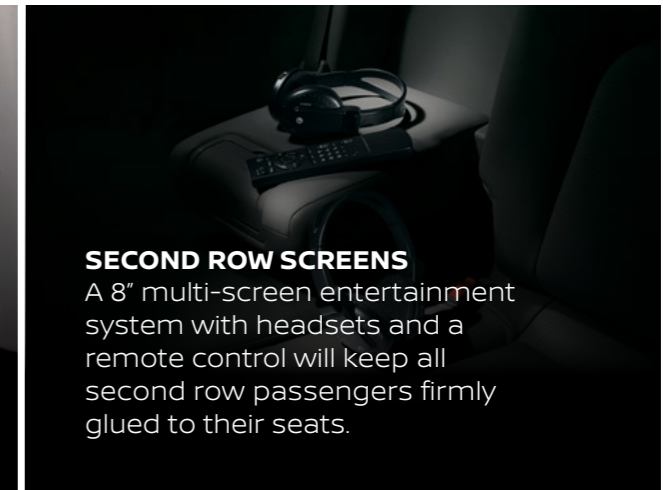

SECOND ROW SCREENS

A 8" multi-screen entertainment system with headsets and a remote control will keep all second row passengers firmly glued to their seats.



SOPHISTICATED INTERIOR REFINEMENT.

A fresh and modern design approach underpinned the creation of the formidable exterior. From the high-tech image of the front head lamps to the dynamic rear end sporting combination lamps, each exterior element on the Nissan PATROL is a statement in luxury. The bold window graphic of the blackened A pillar, alloy wheels, as well as the new angle strut grille all contribute to the vehicle's formidable on-road presence. Chrome finishes on the air intake vents and window frames express dignity and grace. The integrated protective bumper has been designed with perfect approach angle to allow this off-road stalwart to go anywhere.

INTERIOR SPACE

The Nissan PATROL offers the largest interior space in its class. Legroom has increased due to the longer wheelbase, and expansive luggage space is created in seconds through the easy seat folding operation. A built-in cooler box, that incorporates a double hinged design to enable access from both the first and second row seats, has capacity for six 500ml drinking bottles.

QUIET CABIN

In comparison to normal glass, the laminated windshield and front windows reduce noise by 35% in the Nissan PATROL. Ultra micro-fibre insulation, called thinsulate, in the front door panel and luggage areas, provides advanced insulation to maintain the cabin temperature and a quieter cabin.

TEMPERATURE CONTROL

The Nissan PATROL's air conditioning system features curtain vents mounted in the ceiling above each side window and upper vents mounted above the windshield. A strong current of cool air forms a curtain of air that acts as a barrier to heat penetrating the vehicle. Dual Zone climate control allows front and rear passengers to personally set the air conditioning to different levels.

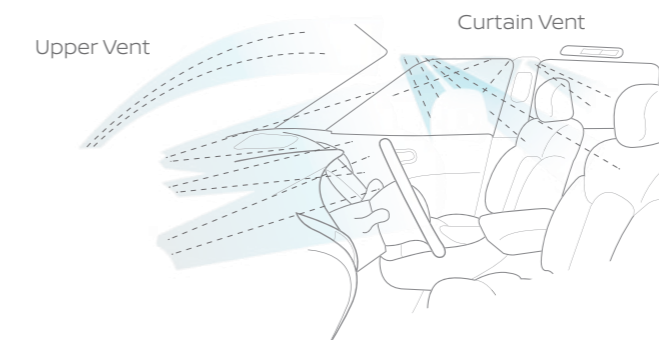



SUPERIOR HANDLING ON AND OFF THE ROAD.

ARMED WITH AN ARRAY OF INGENUOUS TECHNOLOGIES,
THE NISSAN PATROL MAKES EVERY TRIP A PLEASURE.



Smart technology like the innovative **Intelligent Blind Spot Warning and Intelligent Blind Spot Intervention** system detects vehicles in your blind spot and alerts you via an audible alarm. If, for instance you continue to change lanes and the car in your blind spot also continues to proceed, the system will initiate, gently braking one side of the vehicle, bringing your vehicle back to your original lane position, well out of harm's way.



In the Nissan PATROL, you'll feel at ease with **Intelligent Forward Collision Warning**. Using a front distance sensor, it will detect the risk of a forward collision and prompt the driver to brake with an alarm. When the system judges that a collision cannot be prevented, Intelligent Emergency Braking is activated to help the driver reduce the rear-end collision speed by applying the brakes.



Intelligent Lane Departure Warning sounds an audible warning when the driver starts to drift out of its lane. **Intelligent Lane Intervention** detects that you are still straying from your lane, it will engage and gently guide you back.

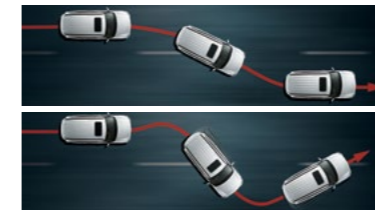

Vehicle Dynamic Control automatically prevents the vehicle from sliding sideways on slippery road surfaces when changing lanes or negotiating a curve.



DRIVE MORE LIKE A PRO.

TRAVELLING OUR ROADS PRESENTS A DIVERSE RANGE OF CHALLENGING LANDSCAPES AND THE NISSAN PATROL IS WELL EQUIPPED TO TACKLE ANY TERRAIN THANKS TO ITS TECHNOLOGY, DESIGN AND FORETHOUGHT.

Intelligent Ride Control system offers 4-wheel independent suspension. Working with the chassis and body frame the system maximises the suspension stroke on off-road running and prevents roll angle, to maintain flat riding with high damping force at cornering. The HBMC system gives the Nissan PATROL superb stability on rugged and sandy terrain, while also delivering a comfortable ride in the city.

Helical Limited Slip Differential (LSD) and Rear Differential Lock allows the driver to maintain momentum, even on slippery slopes or roads when a wheel is spinning or slipping.

Active Brake Limited Slip (ABLS) is a traction control mechanism that uses sensors from the Anti-lock Braking System (ABS) to transfer power from a slipping wheel to a wheel with more traction.

Off-Road Monitor function offers information to support off road driving tyre conditions, while the **Intelligent Tyre Pressure Monitoring System** (TPMS) with tyre inflation indicator provides visual and audible signals outside the vehicle for inflating the tyres to the recommended pressure.

Intelligent Cruise Control helps make driving less tiring on long trips. A simple touch of a button activates the cruise control and allows you to set the desired cruising speed. Using radar to maintain a set speed and distance between you and the vehicle in front of you, even braking to maintain the distance.

Nissan Intelligent Key allows for just the press of a button on the door handle or trunk to unlock them, while the keys remain in the pocket or purse. With the standard Push Start Button feature the vehicle is ready to go with just a push of the button. This technology also memorises the driver's seat position and for added safety the engine immobiliser prevents anyone without the key from starting the car.

SEE MORE AROUND YOU.

MORE SENSITIVITY THAN YOU'D IMAGINE IN SUCH A POWERFUL VEHICLE, NISSAN PATROL IS 100% AWARE OF YOUR SURROUNDINGS AT ALL TIMES.

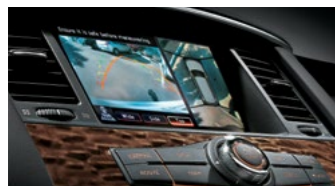

ADVANCED DRIVE ASSIST DISPLAY

Colour monitor which displays front and rear power ratios, the trip computer and fuel economy & external temperature.



INTELLIGENT AROUND-VIEW MONITOR

Leaving nothing to chance, the Nissan PATROL range comes with Intelligent Around-View Monitor allowing drivers to get in and out of tight spots with ease by providing a simulated bird's eye view directly on screen. Intelligent AVM gives you a virtual 360° bird's eye view of your vehicle to bring your parking space and manoeuvring capabilities into full perspective.

SMART REAR-VIEW MIRROR

A built-in LCD monitor, displaying images from a camera mounted on the rear of the Nissan PATROL, providing an unobstructed view.





~~WE MAKE PROMISES.~~ WE KEEP PROMISES.

INTRODUCING NISSAN ASSURED, IT'S MORE THAN A PROMISE. AS PART OF THE NISSAN FAMILY YOU'RE GUARANTEED OUR COMMITMENT TO CUSTOMER CARE. A LASTING BOND BETWEEN YOU, YOUR VEHICLE AND THE NISSAN BRAND. **THAT'S OUR PROMISE.**

CUSTOMER EXPERIENCE

We promise to make your Nissan experience one to cherish, from your delivery day and everyday after, our commitment is to deliver a service experience you can trust – and believe in.

CUSTOMER SUPPORT ROADSIDE ASSISTANCE

We keep you on the road 24/7. Should anything unexpected happen we guarantee you 24-hour roadside assistance, no matter the age of your Nissan, because it's still a Nissan. Just call **0800 NISSAN (64 77 26)** anywhere, anytime. Terms and Conditions do apply.

LICENCE RENEWAL REMINDER

We'll remind you in advance so you can keep your licence disk up to date.

3 YEAR OR 90 000KM SERVICE PLAN

For the first 3 years or 90 000km of driving your car, whichever comes first, you can rest easy knowing that our promise to you is a kept one. We'll make sure your car is running smoothly and always on the road.

6 YEAR OR 150 000KM WARRANTY

As long as your car is under our warranty, we'll always have you covered if anything goes wrong. You don't need to stress for the first 6 years or 150 000km, whichever comes first.

SERVICE AND REPAIRS FREE VEHICLE HEALTH CHECK

We'll give your car a free health check on every major and minor service prior to any work being carried out, so you know exactly what needs to be done, and how much it will cost.

COMPETITIVELY PRICED PARTS

We deliver the highest care for your Nissan by fitting only Nissan Genuine Parts. The expertise of our Nissan trained teams will also guarantee best value-for-money by finding the most competitively priced part for your local dealer.

COURTESY CAR

We will arrange a courtesy car for all warranty repairs should the components required not be available within 48 hours.

NISSAN Assured

More than a promise

Call **0800 NISSAN (64 77 26)**
or visit www.nissan.co.za for more information.

EXCLUSIVE BODY COLOURS



Pearl White - QAC



Brilliant Silver - K23



Gun Metallic - KAD



Black - KH3



Light Beige - HAG



Dark Blue - BW5

TRIM



Interior Black Leather Seat Trim.



Interior Tan Leather Seat Trim.

DIMENSIONS

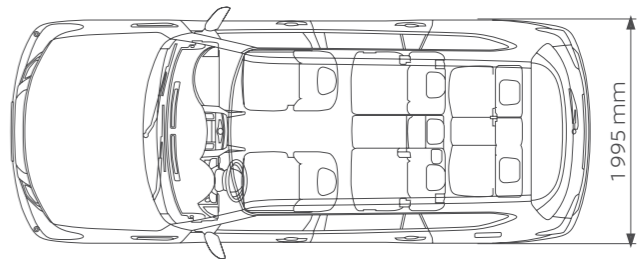
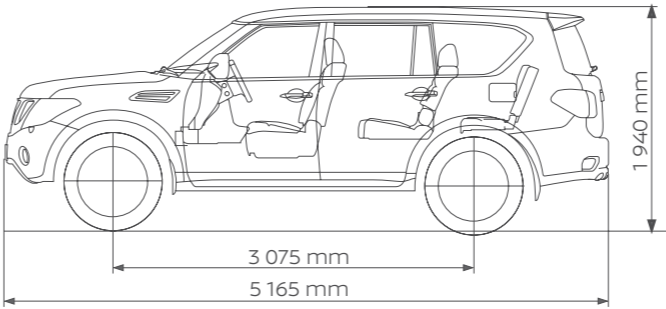

MODEL		5.6 V8 LE 4WD 7AT
MODEL DESCRIPTION		
Body Type		Wagon
Drivetrain		4x4
Fuel Type		Petrol
Engine		5.6 litre V8
Grade		LE
Transmission		7AT
ENGINE INFORMATION		
Engine code		VK56 K1 5.6 litre V8
Displacement	cc	5552
Bore and stroke	mm	98x92
Compression ratio		10.8:1
Maximum power	kW/rpm	298@5800
Maximum torque	Nm/rpm	560@4000
Top speed (Max speed)	km/h	210
Fuel supply		Direct Injection
TRANSMISSION		
7 Speed automatic transmission with Manual Mode & Adaptive Shift Control (ASC)		Standard
Transfer case - ALL MODE 4x4 with electronic 4WD selection		Standard
Ratio 1st		4,8867
Ratio 2nd		3,1697
Ratio 3rd		2,0271
Ratio 4th		1,4118
Ratio 5th		1,0000
Ratio 6th		0,8642
Ratio 7th		0,7745
Ratio Reverse		4,0410
Final drive		3,357
Transfer ratio (low)		2,679
Transfer ratio (high)		1.1
Transfer case / crawl ratios(4wd high)		16,405
Transfer case / crawl ratios(4wd low)		43,948
FUEL		
Fuel type		Premium Unleaded Petrol - 95
Fuel tank capacity	ℓ	140
Fuel consumption, Extra-urban (Highway) *	ℓ/100km	11
Fuel consumption, combined *	ℓ/100km	14,4
CO ² emission		343
Emission standard		Euro V
DIMENSIONS		
Overall length	mm	5165
Overall width (excluding mirrors)	mm	1995
Overall height	mm	1940
Wheelbase	mm	3075
Overhang, front/rear		950/1140
Track Front/Rear	mm	1695/1695
Min. Turning circle (kerb to kerb)	m	12,5
Tare mass	kg	2746
Gross Vehicle Mass (GVM)	kg	3500

MODEL		5.6 V8 LE 4WD 7AT
DIMENSIONS CONTINUED		
Ground Clearance, unladen	mm	272
Approach angle	Degrees	34,3
Departure angle	Degrees	26,2
Ramp angle	Degrees	24,4
Trailer with brakes	kg	3500
Trailer without brakes	kg	750
Gross front axle capacity	kg	1650
Gross rear axle capacity	kg	2030
CHASSIS AND SUSPENSION		
Independent double wishbone coil spring front and rear suspension		Standard
Hydraulic Body Motion Control suspension (front and rear) (HBMC)		Standard
Front and rear ventilated disc brakes		Standard
Rear differential lock		Standard
Rear Helical Limited Slip Differential (LSD)		Standard
Rack-and-pinion power steering		Standard
INTERIOR		
Seating capacity		7
Leather accented† seat trim		Standard
Climate Control FR seats		Standard
8Way/Power (Slide,Reclining) + Lifter + Lumber support + Memory (linked I-Key)		Standard
Driver's seat memory, with two settings, including side mirrors and steering column		Standard
60/40 split-fold second row seating with manual recline and fold function and centre armrest		Standard
60/40 split-fold third row seating with manual recline and fold function		Standard
Leather accented† door trim		Standard
Active Headrest		Standard
Full Auto Dual Zone air-conditioning with Intelligent Key memory		Standard
Audio system with CD/DVD, AM/FM radio, MP3 and USB /iPod+ connectivity with Bluetooth® audio streaming - IT Gen5 Audio platform		Standard
Satellite Navigation with 3D mapping and 8" integrated colour display with touch screen		Standard
Bluetooth® handsfree phone system with steering wheel controls and USB charging port		Standard
12v power outlets (front, centre console, second row and rear luggage area)		4
13 Premium Bose® speakers		Standard
Tilt and telescopic electrically adjustable steering column with Intelligent Key memory		Standard
Leather accented† steering wheel and shift lever		Standard
Steering wheel audio controls		Standard
Sunglasses holder		Standard
Smart Rear View Mirror		Standard
Intelligent Key™ with remote keyless entry		Standard
Push button engine start		Standard
Chrome interior door handles		Standard
Off Road Monitor		Standard
First row centre console cool box		Standard
Glove compartment with lock and light		Standard
Front door operated interior lights		Standard
Front map lights		Standard
Cup holders		4
Bottle holders		8
Rear luggage area light		Standard

MODEL		5.6 V8 LE 4WD 7AT
INTERIOR CONTINUED		
Foot release park brake		Standard
First row and second row auto up/down power windows		Standard
First and second row door pockets		Standard
Two second row seat 8" QHD entertainment screens with headphones and remote control		Standard
6W/ Power (Slide, Reclining) + Lifter (FR/RR Lift Independent)		Standard
Second row air conditioning controls		Standard
Driver and passenger sunvisors with extension and illuminated vanity mirrors		Standard
Front and rear opening centre console storage with armrest		Standard
Second row passenger reading lights		Standard
Driver and passenger assist grips (first, second and third row)		6
Driver and front passenger back pocket		Standard
First and second row door armrest		Standard
Second row coat hanger hooks		2
Cargo net hooks		Standard
INSTRUMENTATION		
Intelligent ALL-MODE 4WD shift switch (Auto, 4H & 4L) with mode select (On Road, Sand, Rock)		Standard
Drive Computer		Standard
With Tachometer		Standard
Cluster C Color Display Clock		Standard
Low fuel level warning indicator		Standard
With Outside Thermometer		Standard
Dash illumination control		Standard
Lights on warning		Standard
Chrome interior door handles		Standard
SAFETY/SECURITY		
Intelligent Around View® Monitor (AVM)		Standard
Front and rear parking sensors		Standard
Vehicle Dynamic Control (VDC) including Traction Control System (TCS)		Standard
Anti-Lock Braking System (ABS) and Electronic Brakeforce Distribution (EBD)		Standard
Hill Descent Control (HDC) with on/off switch and Hill Start Assist (HSA)		Standard
Nissan Anti Theft System (NATS) vehicle immobiliser and bonnet alarm		Standard
Driver and passenger front and side-impact SRS airbags		Standard
Curtain SRS airbag		Standard
Driver and passenger 3 point ELR seatbelts with pretensioners, load limiters and height adjustment		Standard
Second and third row 3 point ELR seatbelts		Standard
Child restraint anchorage points		3
Driver and passenger seatbelt warning and reminder		Standard
Front adjustable active headrests		Standard
Rear adjustable headrests		Standard
Intelligent Cruise Control (ICC)		Standard
Intelligent Forward Collision Warning (FCW)		Standard
Intelligent Distance Control Assist (DCA)		Standard

MODEL		5.6 V8 LE 4WD 7AT
SAFETY/SECURITY CONTINUED		
Intelligent Lane Departure Warning and Prevention (LDW & LDP)		Standard
Intelligent Blind Spot Warning and Intervention (BSW & BSI)		Standard
Intelligent Brake Assist (IBA)		Standard
Tyre Pressure Monitoring System (TPMS)		Standard
EXTERIOR		
Front fog lights		Standard
Automatic headlight leveliser		Standard
Xenon headlights		Standard
Delay timer headlight function		Standard
Headlight washers		Standard
Heated door mirrors with power adjustment/folding with Intelligent Key memory & integrated indicator lights		Standard
Puddle illumination light		Standard
Front variable intermittent, mist, rain sensing wipers		Standard
Rear intermittent wiper		Standard
Front windscreen with laminated glass		Standard
Front door UV reducing glass		Standard
Front and rear mud guards		Standard
Side steps		Standard
Sunroof (electric one-touch power tilt & slide)		Standard
Power operated tailgate		Standard
LED rear combination light		Standard
Rear spoiler		Standard
Front and rear towing hooks		Standard
Rear side, back and sunroof privacy glass		Standard
Electromagnetic fuel lid opener		Standard
WHEELS/TYRES		
18" x 8J alloy wheels		Standard
265/70R18 tyres		Standard
Full size alloy spare wheel		Standard
OWNERSHIP		
Service interval		15,000 km
Service plan		3 year / 90 000 km
Roadside Assistance		6 year / 150,000 km
Warranty		6 year / 150,000 km
ACCESSORIES		
Tow bar - detachable flange type	B05Y62TB	Optional
Towing electrical kit - 7 Pin harness	KE5051L207	Optional

Disclaimer:

Tow bar and towing kit is available as a Nissan Approved Accessory through an authorised Nissan dealer.

Legal Notice

Every effort has been made to ensure that the content of this brochure is correct at the time of going to print. This brochure has been produced featuring prototype or accessorised vehicles exhibited at motor shows and, in accordance with the company's policy of continuously improving its products, Nissan South Africa reserves the right to change the specification and the vehicles described and shown in this brochure at any time. Nissan Dealers will be informed of any such modifications as quickly as possible. Please check with your local Nissan Dealer to receive the most up-to-date information. Due to the limitations of the printing processes used, the colours shown in this brochure may differ slightly from the actual colours of the paint and interior trim materials used. All rights reserved. Reproduction in whole or part of this brochure without the written permission from Nissan is forbidden. Quoted fuel consumption and emission values have been established using the prescribed method of measurement (United Nations Economic Commission for Europe "ECE" Regulation R101 in the current version) as required under current legislation. This data does not pertain to the specific vehicle and does not comprise part of the offer, but is supplied for the purpose of comparison between the various types of vehicles, in accordance with 1999/94/EC. Driving behaviour / conditions and other non-technical factors contribute towards a vehicle's fuel consumption and CO₂ emissions over and above the determined fuel efficiency of a vehicle.



Nissan's commitment to the environment

Nissan's environmental philosophy embraces people, vehicles and nature. In the pursuit of a sustainable mobile society, the Nissan Green Program aims to reduce the environmental impact of Nissan vehicles at every stage of the vehicle life cycle, while corporate activities address environmental challenges.

NISSAN'S commitment to quality:

to provide all customers with a consistently high level of quality. Nissan applies the standard worldwide, to ensure that all Nissan owners enjoy peace of mind for the lives of their vehicles. The approach is based on quality from the customer's perspective on three key elements: 1. The expectation of a smooth driving experience with complete peace of mind. 2. The intangible appeal of a vehicle, its power to captivate and excite, with features that capture attention and imagination. 3. The level of attentiveness and service during the sales process, and long after the sale is concluded.



Nissan Intelligent Mobility moves you one step ahead. In cars that feel like an extension of you, helping you see more and sense more, reacting with you, and sometimes even for you. Nissan Intelligent Mobility is about a better future - moving us to a world that's safer, more sustainable, and exciting.

visit our website at: www.nissan.co.za

Phone us toll free on: 0800 NISSAN (647 726)

Follow Nissan on:

 /NissanSouthAfrica

 @Nissanza

OCTOBER 2020

BR20E-Y62ZA1